

Sensor Tap



BROEN-LAB

General information

Sensor Tap for cold, hot or tepid water

The sensor tap offers handsfree distribution of potable cold, hot or tepid water. The Sensor Tap comes as a stand-alone version for a fixed water temperature or as a mixing version with either manual or thermostatic regulation of water temperature. It is coated with a chemical resistant polyester-based surface treatment, making it ideal for laboratories environments.

The boxes below explains the options and media that you have to decide between when you order a BROEN-LAB sensor tap. If you have a query not found, please contact BROEN-LAB.



Options

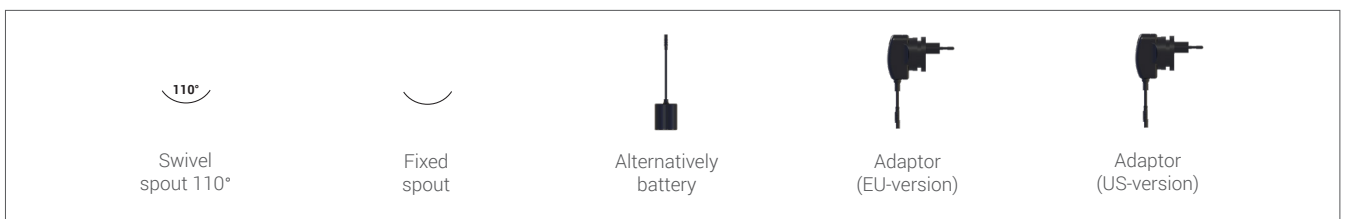

Accessories

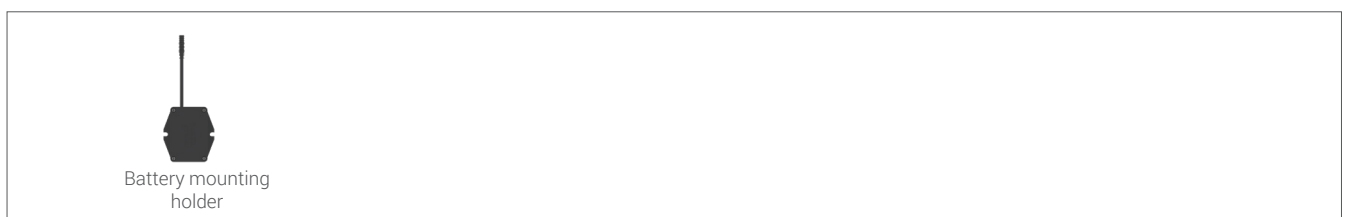

Sensor Tap for fixed temperature

M30x1.5 mm mounting

Specifications

Aerator, with flow limitation 5 L/min
 Sensor operated opening and closing function with bi-stable technology
 110° limited swivel spout

Temperatur range: 5-65° (41°F - 149°F)
 Max. working pressure: 10 bar/145 psi

Surface

Chemical resistant Polyester Based Surface treatment,
 UV-resistant.
 BROEN-LAB colour: 2700 (RAL colour: 0008500)

Material with media contact

Brass
 Rubber, EPDM
 Silicone based lubricant
 PPSU
 SS
 PA
 SPX Hose

Electrical connection

Adaptor: 100-240 V AC 50/60 Hz
 Battery: 6 V Lithium

Hose

Supplied with hoses.
 Hose (1) on the picture is mandatory and included. Hose (2) on the picture is optional. See in the table below which options you have for hose (2)*.

For further options contact BROEN-LAB

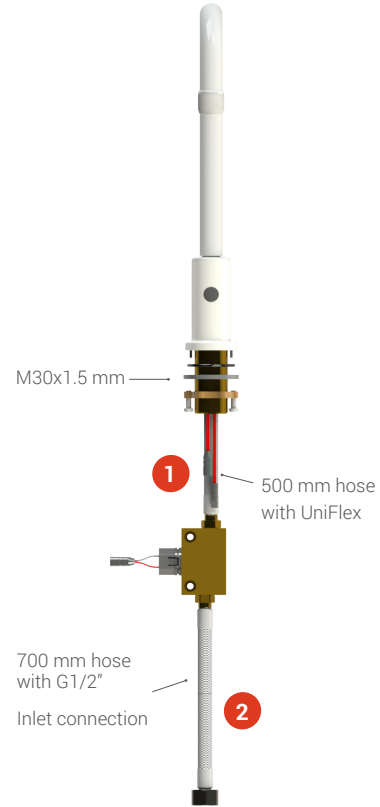

Note: Bench mounted version on the picture

Configuration options

Choose mounting and spout, swivel limitation or fixed spout and battery or adaptor.

	110°	110° EU	110° USA	Fixed	Fixed EU	Fixed USA
Bench mounted Standard spout	2601 008 XX 35-52E	2601 017 1035-52E	2601 023 2035-52E	2601 002 XX 35-52E	2601 018 1035-52E	2601 026 2035-52E
Wall mounted Standard spout	2601 032 XX 35-50E	2601 033 1035-50E	2601 038 2035-50E	2601 034 XX 35-50E	2601 035 1035-50E	2601 039 2035-50E
Bench mounted Basin spout	-	-	-	2601 020 XX 35-52E	2601 022 1035-52E	2601 037 3035-52E

XX = Country code: [EU: **10** ; US: **20**]

*Standard hose is G1/2" (Code "E", placed in the end of the product number) but you can choose between the recommended hoses below

Recommended accessories

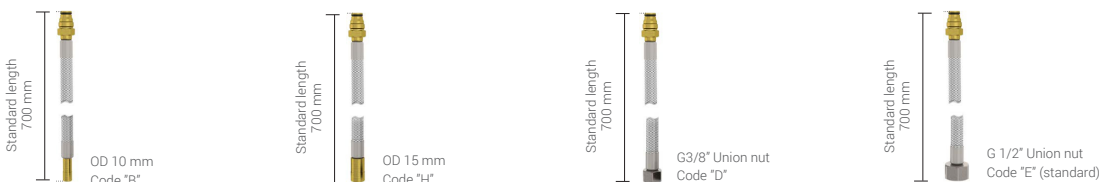

Sensor Tap with temperature adjustor

M30x1.5 mm mounting

Specifications

Aerator, with flow limitation 5 L/min
 Sensor operated opening and closing function with bi-stabile technology
 110° limited swivel spout
 Non-return valve integrated in valvhouse
 Temperatur range: 5-65° (41°F - 149°F)
 Max. working pressure: 10 bar/145 psi

Surface

Chemical resistant Polyester Based Surface treatment,
 UV-resistant.
 BROEN-LAB colour: 2700 (RAL colour: 0008500)

Material with media contact

Brass
 Rubber, EPDM
 Silicone based lubricant
 PPSU
 SS
 PA
 SPX Hose

Electrical connection

Adaptor: 100-240 V AC 50/60 Hz
 Battery: 6 V Lithium

Hose

Supplied with hoses.
 Hose (1) and (2) on the picture are mandatory and included. The hoses (3) on the picture are optional. See in the table below which options you have for the hoses (3)*.

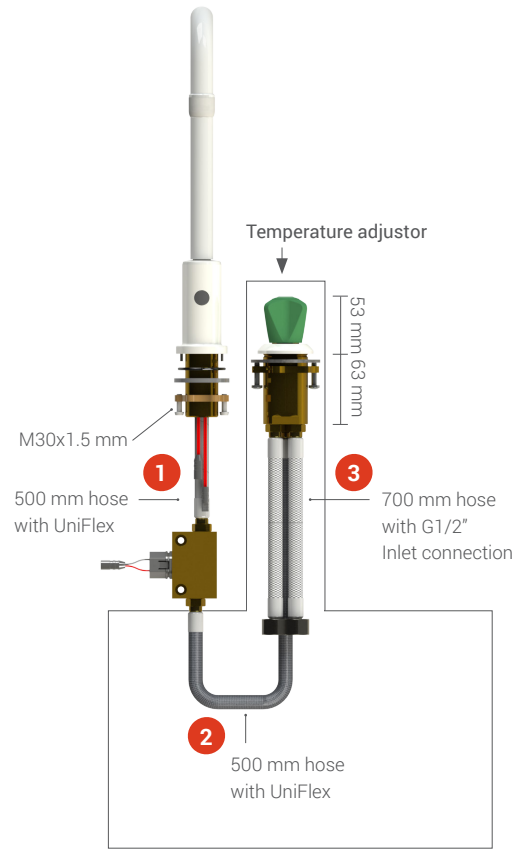

Note: Bench mounted version on the picture

For further options contact BROEN-LAB

Configuration options

Choose mounting and spout, swivel limitation or fixed spout and battery or adaptor.

	110°	110° EU	110° USA	Fixed	Fixed EU	Fixed USA
Bench mounted Standard spout	2601 008 XX35-52 + 2602 002 XX35E	2601 017 1035-52 + 2602 002 XX35E	2601 023 2035-52 + 2602 002 XX35E	2601 002 XX35-52 + 2602 002 XX35E	2601 018 1035-52 + 2602 002 XX35E	2601 026 2035-52 + 2602 002 XX35E
Wall mounted Standard spout	2601 032 XX35-50 + 2602 002 XX35E	2601 033 1035-50 + 2602 002 XX35E	2601 038 2035-50 + 2602 002 XX35E	2601 034 XX35-50 + 2602 002 XX35E	2601 035 1035-50 + 2602 002 XX35E	2601 039 2035-50 + 2602 002 XX35E
Bench mounted Basin spout	-	-	-	2601 020 XX35-52 + 2602 002 XX35E	2601 022 1035-52 + 2602 002 XX35E	2601 037 3035-52 + 2602 002 XX35E

XX = Country code: [EU: 10 ; US: 20]

*Standard hose is G1/2" (Code "E", placed in the end of the product number) but you can choose between the recommended hoses below

Recommended accessories

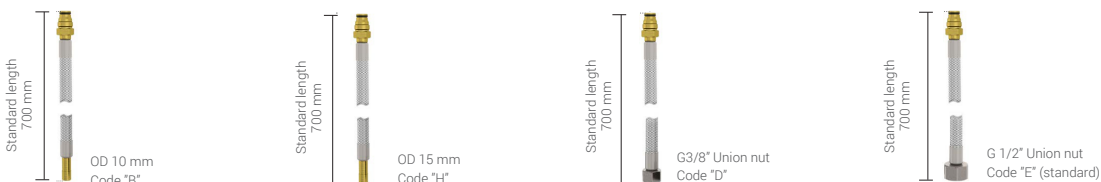

Sensor Tap with thermostatic mixing valve and built-in anti-scalding device

M30x1.5 mm mounting

Specifications

- Aerator, with flow limitation 5 L/min
- Sensor operated opening and closing function with bi-stabile technology
- 110° limited swivel spout
- Non-return valves integrated in valvehouse
- Temperature range: Pre-set 37 °C (98 °F)
- Max. working pressure: 10 bar/145 psi

Surface

Chemical resistant Polyester Based Surface treatment, UV-resistant.
BROEN-LAB colour: 2700 (RAL colour: 0008500)

Material with media contact

- Brass
- Rubber, EPDM
- Silicone based lubricant
- PPSU
- SS
- PA
- SPX Hose

Electrical connection

Adaptor: 100-240 V AC 50/60 Hz
Battery: 6 V Lithium

Hose

Supplied with hoses.
Hose (1) and (2) on the picture are mandatory and included.
The hoses (3) on the picture are optional. See in the table below which options you have for the hoses (3)*.

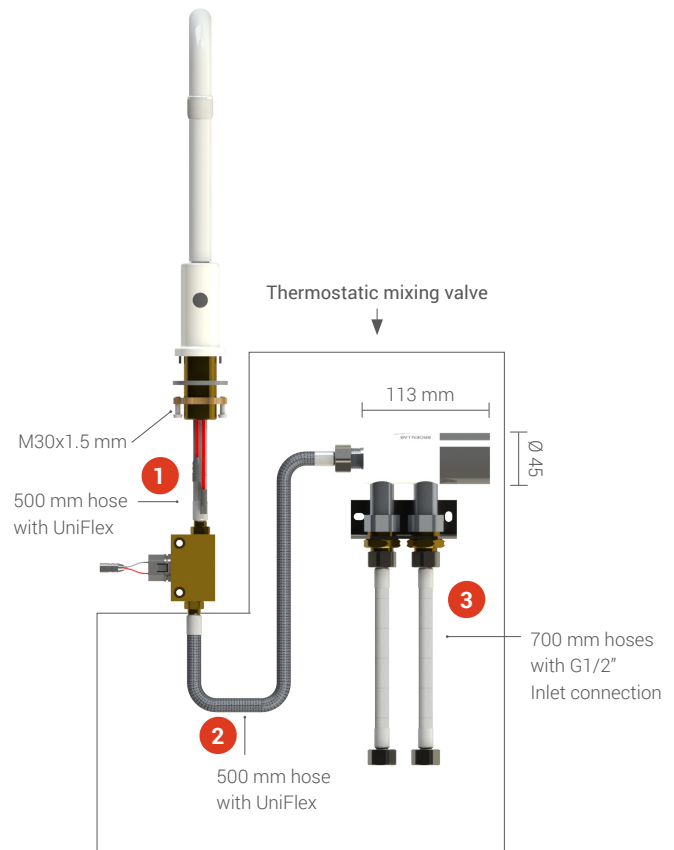

Note: Bench mounted version on the picture

For further options contact BROEN-LAB

Configuration options

Choose mounting and spout, swivel limitation or fixed spout and battery or adaptor.

	110°	110° EU	110° USA	Fixed	Fixed EU	Fixed USA
Bench mounted Standard spout	2601 008 XX35-52 + 2603 004 XX35E	2601 017 1035-52 + 2603 004 XX35E	2601 023 2035-52 + 2603 004 XX35E	2601 002 XX35-52 + 2603 004 XX35E	2601 018 1035-52 + 2603 004 XX35E	2601 026 2035-52 + 2603 004 XX35E
Wall mounted Standard spout	2601 032 XX35-50 + 2603 004 XX35E	2601 033 1035-50 + 2603 004 XX35E	2601 038 2035-50 + 2603 004 XX35E	2601 034 XX35-50 + 2603 004 XX35E	2601 035 1035-50 + 2603 004 XX35E	2601 039 2035-50 + 2603 004 XX35E
Bench mounted Basin spout	-	-	-	2601 020 XX35-52 + 2603 004 XX35E	2601 022 1035-52 + 2603 004 XX35E	2601 037 3035-52 + 2603 004 XX35E

XX = Country code: [EU: 10 ; US: 20]

*Standard hose is G1/2" (Code "E", placed in the end of the product number) but you can choose between the recommended hoses below

Recommended accessories

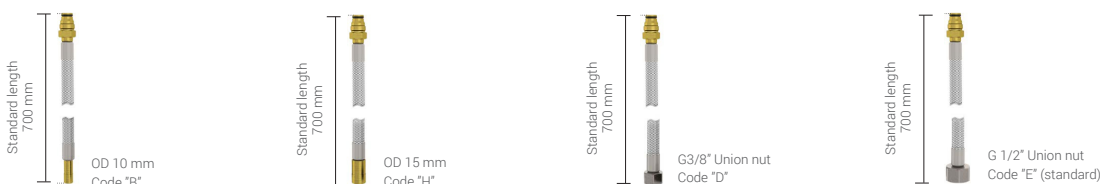

BROEN-LAB develops, manufactures and sells Laboratory Fittings, Emergency Shower Systems and Eye Wash Systems into a broad spectrum of laboratories and industrial locations; sectors include Pharmaceutical, Food&Beverage and Academia. Our expertise and product quality ensure optimal solutions compliant to all relevant international norms setting new standards in risk mitigation in modern research and development facilities.

BROEN-LAB offer solutions that ensure the functionality, compliance, hygiene, durability and safety are of the highest priority. For over 50 years our products have been integrated into a wide variety of workplaces, laboratories, hospitals and industrial locations, with features that are assessed and designed to be flexible, durable and compliant offering a broad range of options tailored to each location. This inherent design integrity provides confidence in the solution adopted wherever in the world these are applied.

BROEN-LAB is a collaboration partner in the design and layout of your next laboratory and it's integrated safety

HEAD OFFICE

BROEN-LAB A/S

Drejervaenget 2 • DK-5610 Assens
Tel. +45 6376 6376 • Fax +45 6471 2476
E-mail: lab@broen-lab.com



BROEN-LAB A/S ISO 9001 certification

In September 1991 BROEN-LAB A/S was certified according to ISO 9001 as one of the first Danish companies. The certification was carried out by Bureau Veritas, Denmark, for our Danish site in Assens. The quality management system of BROEN-LAB A/S now complies with detailed specifications laid down by the internationally acknowledged EN ISO 9001:2015. This certification will further contribute to reputation for quality and reliability of BROEN-LAB A/S.

INTERNATIONAL OFFICES

BROEN-LAB Ltd.

Tel. +44 121 522 4515 • Fax +44 121 522 4535
E-mail: lab@broen-lab.com

BROEN-LAB Singapore Pte. Ltd.

25 International Business Park • #04-60A German Centre • Singapore 658079
Tel: +65 6298 0662 • Fax: +65 6298 0468
E-mail: lab@broen-lab.com

BROEN-LAB GmbH

Tel. +45 6376 6376 • Fax +45 6471 2476
E-mail: lab@broen-lab.com

BROEN-LAB Sverige AB

Tel. +45 6376 6376 • Fax +45 6471 2476
E-mail: lab@broen-lab.com

BROEN-LAB Inc.

15 Constitution Drive • Suite 122 • NH 03110 • Bedford • USA
Tel. +1 603 310 5089
E-mail: lab@broen-lab.com

broen-lab.com

BROEN-LAB